

TOSHIBA FIELD EFFECT TRANSISTOR SILICON P CHANNEL MOS TYPE

2SJ200

HIGH POWER AMPLIFIER APPLICATION

Unit in mm

- High Breakdown Voltage : $V_{DSS} = -180V$
- High Forward Transfer Admittance : $|Y_{fs}| = 4.0S$ (Typ.)
- Complementary to 2SK1529

MAXIMUM RATINGS ($T_a = 25^\circ C$)

CHARACTERISTIC	SYMBOL	RATING	UNIT
Drain-Source Voltage	V_{DSS}	-180	V
Gate-Source Voltage	V_{GSS}	± 20	V
Drain Current	I_D	-10	A
Drain Power Dissipation ($T_c = 25^\circ C$)	P_D	120	W
Channel Temperature	T_{ch}	150	$^\circ C$
Storage Temperature Range	T_{stg}	-55~150	$^\circ C$

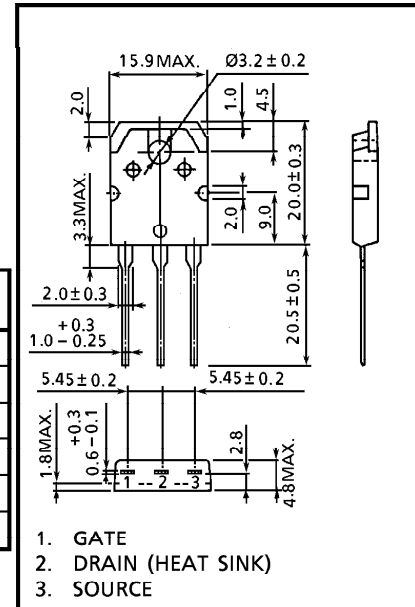

1. GATE
2. DRAIN (HEAT SINK)
3. SOURCE

JEDEC	—
EIAJ	SC-65
TOSHIBA	2-16C1B

Weight : 4.7g

MARKING

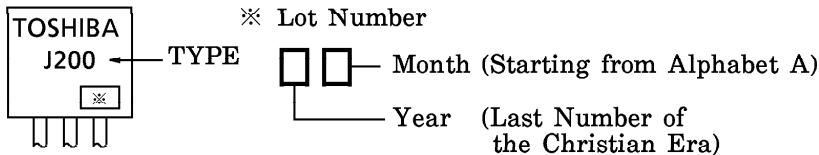

ELECTRICAL CHARACTERISTICS ($T_a = 25^\circ C$)

CHARACTERISTIC	SYMBOL	TEST CONDITION	MIN.	TYP.	MAX.	UNIT
Drain Cut-Off Current	I_{DSS}	$V_{DS} = -180V, V_{GS} = 0$	—	—	-1.0	mA
Gate Leakage Current	I_{GSS}	$V_{DS} = 0, V_{GS} = \pm 20V$	—	—	± 0.5	μA
Drain-Source Breakdown Voltage	$V(BR)_{DSS}$	$I_D = -10mA, V_{GS} = 0$	-180	—	—	V
Gate-Source Cut-Off Voltage	$V_{GS(OFF)}$ (Note)	$V_{DS} = -10V, I_D = -0.1A$	-0.8	—	-2.8	V
Drain-Source Saturation Voltage	$V_{DS(ON)}$	$I_D = -6A, V_{GS} = -10V$	—	-1.5	-5.0	V
Forward Transfer Admittance	$ Y_{fs} $	$V_{DS} = -10V, I_D = -3A$	—	4.0	—	S
Input Capacitance	C_{iss}	$V_{DS} = -30V, V_{GS} = 0, f = 1MHz$	—	1300	—	pF
Output Capacitance	C_{oss}	$V_{DS} = -30V, V_{GS} = 0, f = 1MHz$	—	350	—	pF
Reverse Transfer Capacitance	C_{rss}	$V_{DS} = -30V, V_{GS} = 0, f = 1MHz$	—	200	—	pF

(Note) $V_{GS(OFF)}$ Classification O : -0.8~-1.6, Y : -1.4~-2.8

This transistor is an electrostatic sensitive device.

Please handle with caution.

961001EAA2

● TOSHIBA is continually working to improve the quality and the reliability of its products. Nevertheless, semiconductor devices in general can malfunction or fail due to their inherent electrical sensitivity and vulnerability to physical stress. It is the responsibility of the buyer, when utilizing TOSHIBA products, to observe standards of safety, and to avoid situations in which a malfunction or failure of a TOSHIBA product could cause loss of human life, bodily injury or damage to property. In developing your designs, please ensure that TOSHIBA products are used within specified operating ranges as set forth in the most recent products specifications. Also, please keep in mind the precautions and conditions set forth in the TOSHIBA Semiconductor Reliability Handbook.

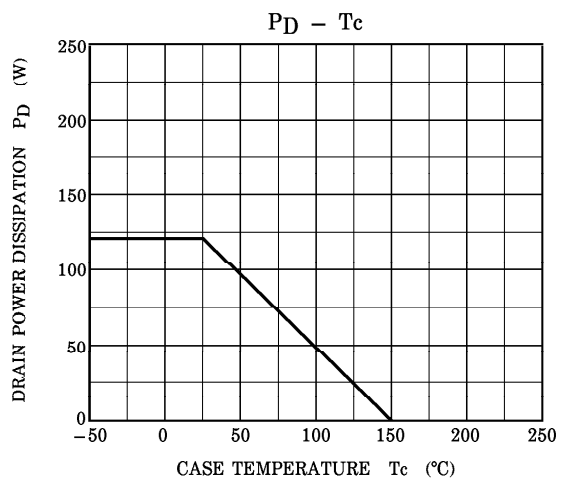
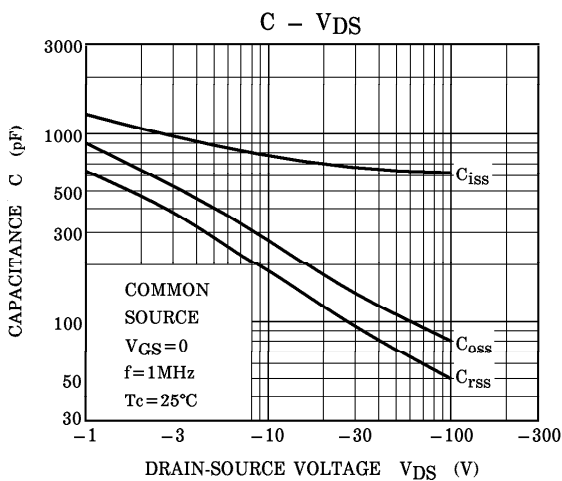
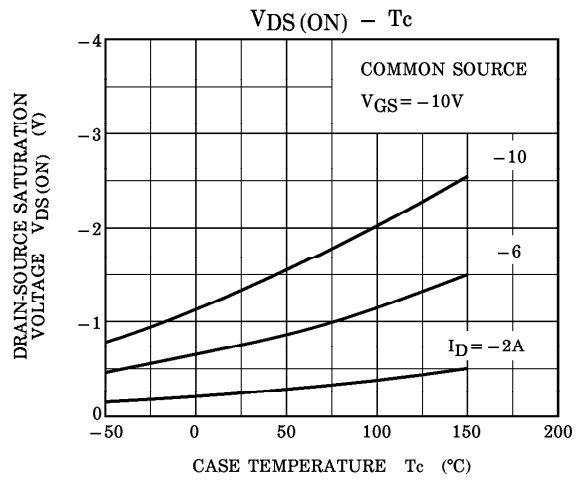
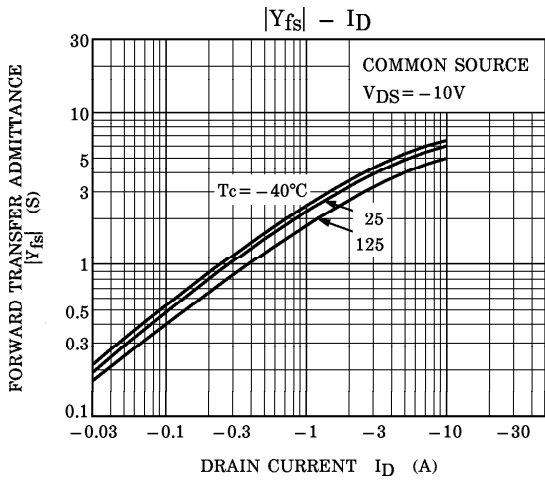
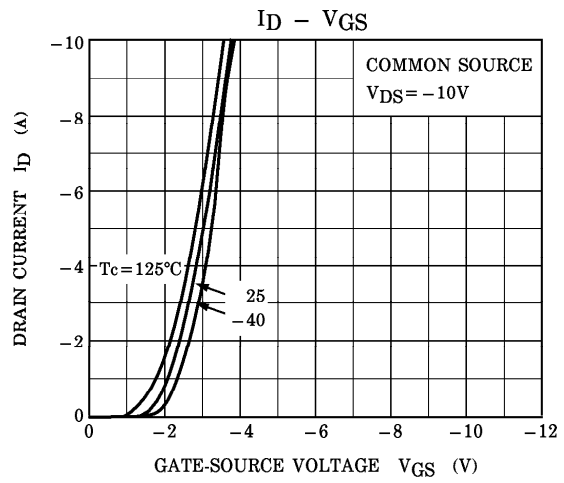
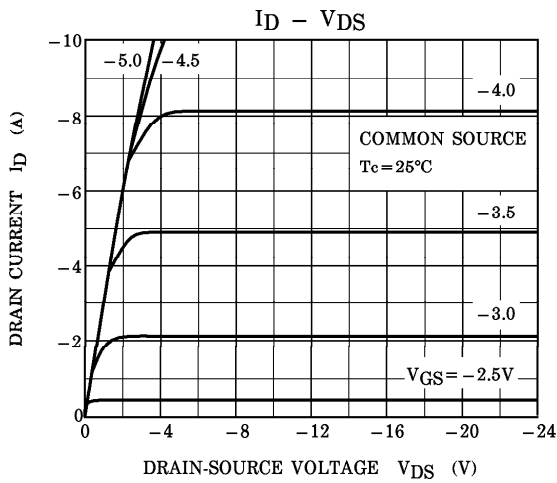

961001EAA2'

● The information contained herein is presented only as a guide for the applications of our products. No responsibility is assumed by TOSHIBA CORPORATION for any infringements of intellectual property or other rights of the third parties which may result from its use. No license is granted by implication or otherwise under any intellectual property or other rights of TOSHIBA CORPORATION or others.
 ● The information contained herein is subject to change without notice.

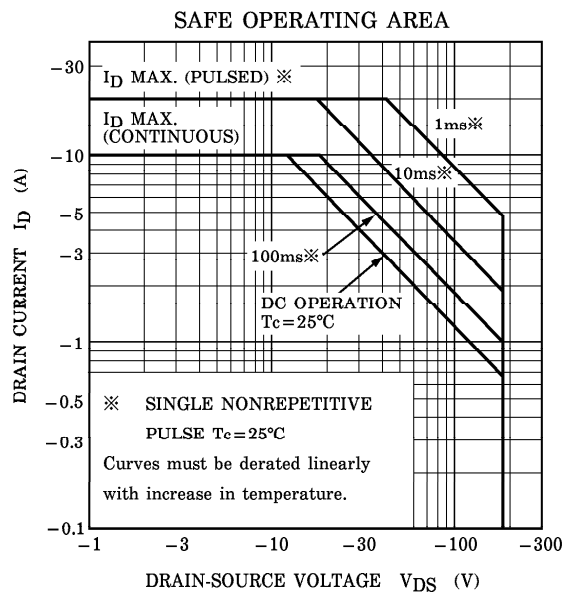
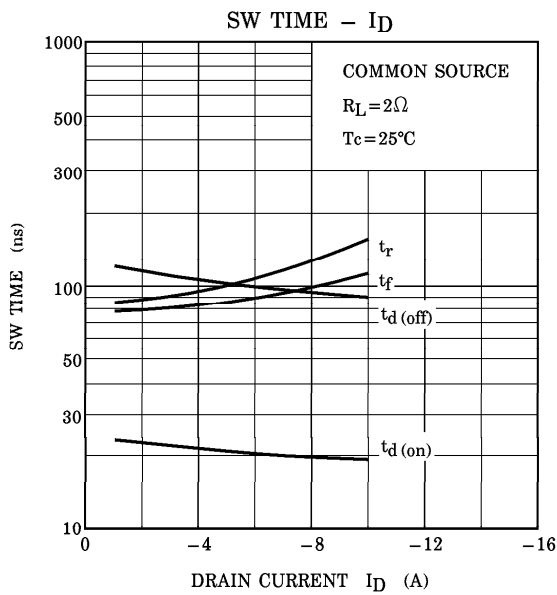

SWITCHING TIME TEST CIRCUIT

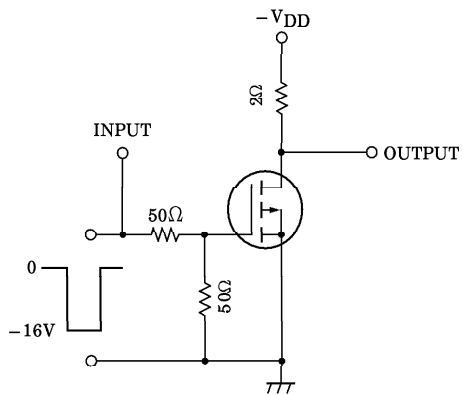

WAVEFORMS

