



STP80NF10 STP80NF10FP

N-CHANNEL 100V - 0.012Ω - 80A TO-220/TO-220FP
LOW GATE CHARGE STRIPFET™II POWER MOSFET

TYPE	V _{DSS}	R _{DS(on)}	I _D
STP80NF10	100 V	< 0.015 Ω	80 A
STP80NF10FP	100 V	< 0.015 Ω	38 A

- TYPICAL R_{DS(on)} = 0.012Ω
- EXCEPTIONAL dv/dt CAPABILITY
- 100% AVALANCHE TESTED
- APPLICATION ORIENTED CHARACTERIZATION

DESCRIPTION

This Power MOSFET series realized with STMicroelectronics unique STRIPFET process has specifically been designed to minimize input capacitance and gate charge. It is therefore suitable as primary switch in advanced high-efficiency isolated DC-DC converters for Telecom and Computer application. It is also intended for any application with low gate charge drive requirements.

APPLICATIONS

- HIGH-EFFICIENCY DC-DC CONVERTERS
- UPS AND MOTOR CONTROL

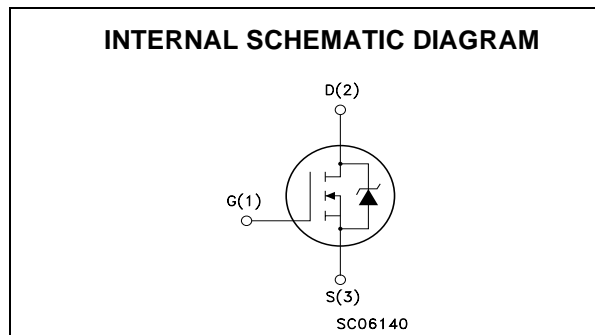
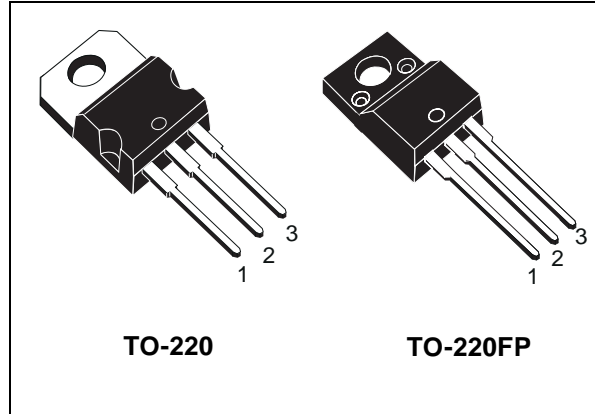

ABSOLUTE MAXIMUM RATINGS

Symbol	Parameter	Value		Unit
		STP80NF10	STP80NF10FP	
V _{DS}	Drain-source Voltage (V _{GS} = 0)	100		V
V _{DGR}	Drain-gate Voltage (R _{GS} = 20 kΩ)	100		V
V _{GS}	Gate- source Voltage	±20		V
I _D (*)	Drain Current (continuous) at T _C = 25°C	80	38	A
I _D	Drain Current (continuous) at T _C = 100°C	66	27	A
I _{DM} (●)	Drain Current (pulsed)	320	152	A
P _{TOT}	Total Dissipation at T _C = 25°C	300	45	W
	Derating Factor	2	0.3	W/°C
dv/dt (1)	Peak Diode Recovery voltage slope	9		V/ns
E _{AS} (2)	Single Pulse Avalanche Energy	360		mJ
V _{ISO}	Insulation Withstand Voltage (DC)	-	2500	V
T _{stg}	Storage Temperature	- 55 to 175		°C
T _j	Max. Operating Junction Temperature			

(●) Pulse width limited by safe operating area
(*) Limited by Package

(1) I_{SD} ≤ 80A, di/dt ≤ 300A/μs, V_{DD} ≤ V_{(BR)DSS}, T_j ≤ T_{JMAX}.
(2) Starting T_j = 25°C, I_D = 80A, V_{DD} = 50V

STP80NF10/STP80NF10FP

THERMAL DATA

		TO-220	TO-220FP	
Rthj-case	Thermal Resistance Junction-case Max	0.5	3.33	°C/W
Rthj-amb	Thermal Resistance Junction-ambient Max	62.5		°C/W
T _I	Maximum Lead Temperature For Soldering Purpose	300		°C

ELECTRICAL CHARACTERISTICS (T_{CASE} = 25 °C UNLESS OTHERWISE SPECIFIED)

OFF

Symbol	Parameter	Test Conditions	Min.	Typ.	Max.	Unit
V _{(BR)DSS}	Drain-source Breakdown Voltage	I _D = 250 μA, V _{GS} = 0	100			V
I _{DSS}	Zero Gate Voltage Drain Current (V _{GS} = 0)	V _{DS} = Max Rating V _{DS} = Max Rating, T _C = 125 °C			1 10	μA μA
I _{GSS}	Gate-body Leakage Current (V _{DS} = 0)	V _{GS} = ±20V			±100	nA

ON (1)

Symbol	Parameter	Test Conditions	Min.	Typ.	Max.	Unit
V _{GS(th)}	Gate Threshold Voltage	V _{DS} = V _{GS} , I _D = 250μA	2	3	4	V
R _{DS(on)}	Static Drain-source On Resistance	V _{GS} = 10V, I _D = 40 A		0.012	0.015	Ω

DYNAMIC

Symbol	Parameter	Test Conditions	Min.	Typ.	Max.	Unit
g _{fs} (1)	Forward Transconductance	V _{DS} = 25V, I _D = 40 A		80		S
C _{iss}	Input Capacitance	V _{DS} = 25V, f = 1 MHz, V _{GS} = 0		4300		pF
C _{oss}	Output Capacitance			600		pF
C _{rss}	Reverse Transfer Capacitance			230		pF

ELECTRICAL CHARACTERISTICS (CONTINUED)
SWITCHING ON

Symbol	Parameter	Test Conditions	Min.	Typ.	Max.	Unit
$t_{d(on)}$	Turn-on Delay Time	$V_{DD} = 50V, I_D = 40A$		40		ns
t_r	Rise Time	$R_G = 4.7\Omega, V_{GS} = 10V$ (see test circuit, Figure 3)		145		ns
Q_g	Total Gate Charge	$V_{DD} = 80V, I_D = 80A,$		140	189	nC
Q_{gs}	Gate-Source Charge	$V_{GS} = 10V$		23		nC
Q_{gd}	Gate-Drain Charge			51		nC

SWITCHING OFF

Symbol	Parameter	Test Conditions	Min.	Typ.	Max.	Unit
$t_{d(off)}$	Turn-off-Delay Time	$V_{DD} = 50V, I_D = 40A,$		134		ns
t_f	Fall Time	$R_G = 4.7\Omega, V_{GS} = 10V$ (see test circuit, Figure 3)		115		ns

SOURCE DRAIN DIODE

Symbol	Parameter	Test Conditions	Min.	Typ.	Max.	Unit
I_{SD}	Source-drain Current				80	A
$I_{SDM} (2)$	Source-drain Current (pulsed)				320	A
$V_{SD} (1)$	Forward On Voltage	$I_{SD} = 80A, V_{GS} = 0$			1.3	V
t_{rr}	Reverse Recovery Time	$I_{SD} = 80A, di/dt = 100A/\mu s,$		155		ns
Q_{rr}	Reverse Recovery Charge	$V_{DD} = 50V, T_j = 150^\circ C$		0.85		μC
I_{RRM}	Reverse Recovery Current	(see test circuit, Figure 5)		11		A

Note: 1. Pulsed: Pulse duration = 300 μs , duty cycle 1.5 %.
2. Pulse width limited by safe operating area.

Safe Operating Area for TO-220

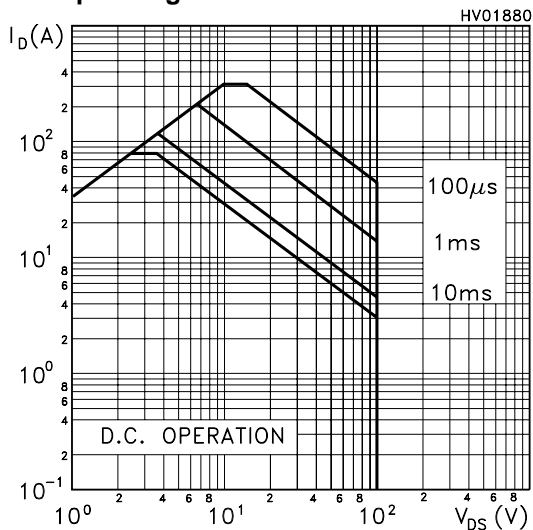

Safe Operating Area for TO-220FP

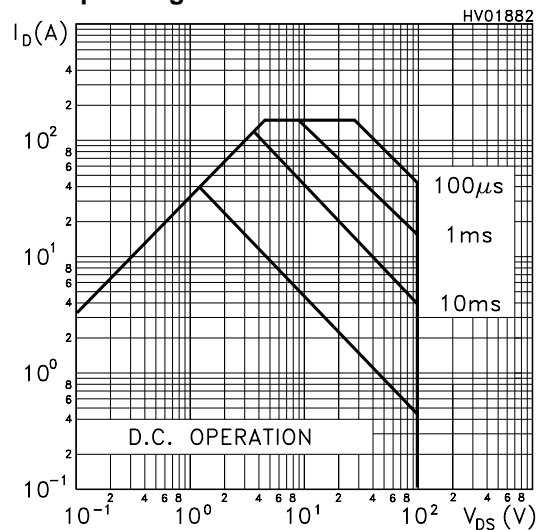

Thermal Impedance for TO-220

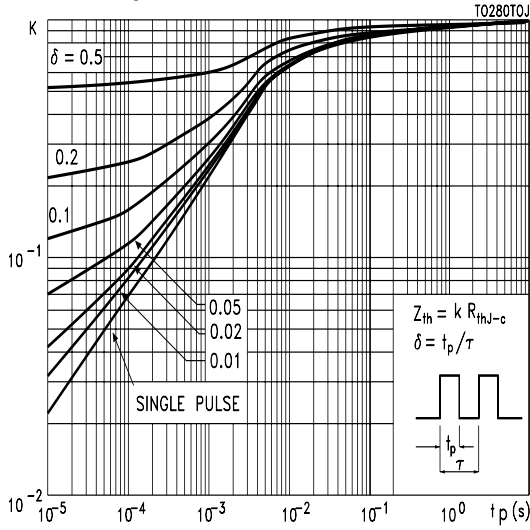

Thermal Impedance for TO-220FP

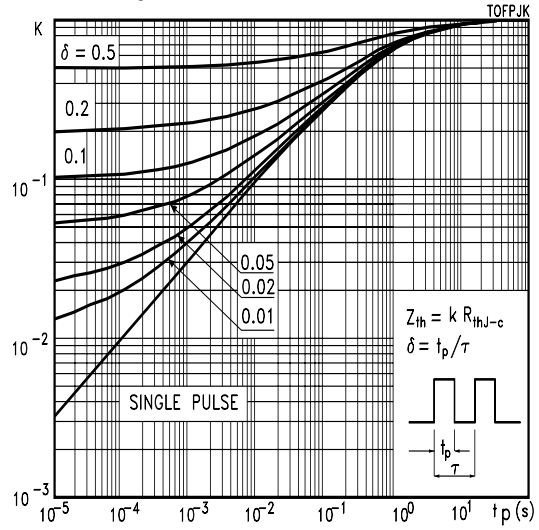

Output Characteristics

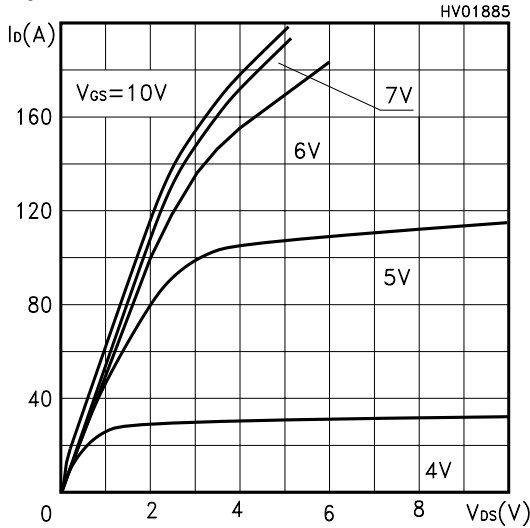

Transfer Characteristics

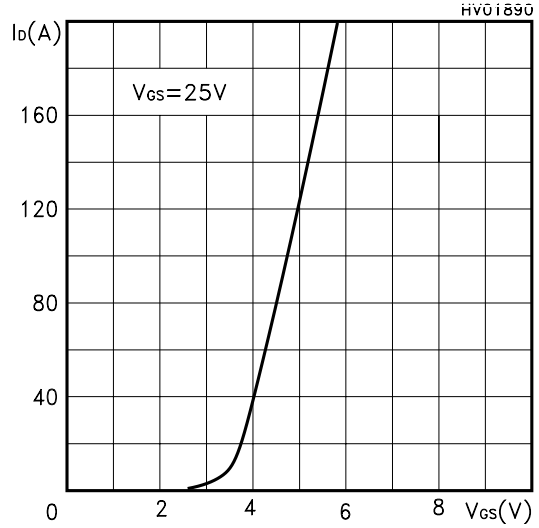

Transconductance

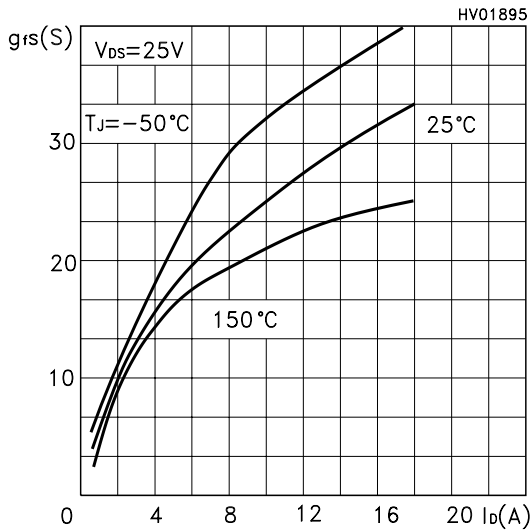

Static Drain-source On Resistance

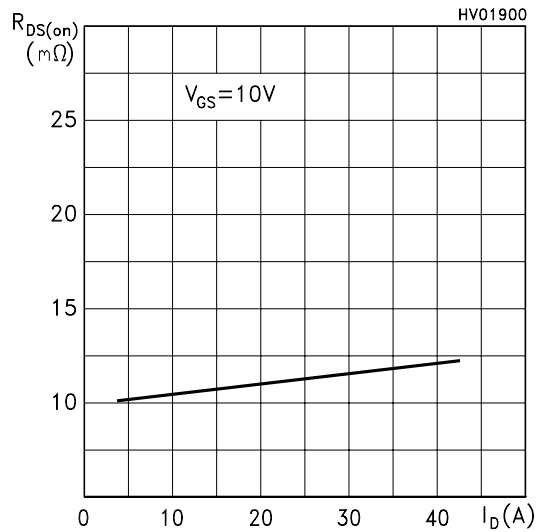

Gate Charge vs Gate-source Voltage

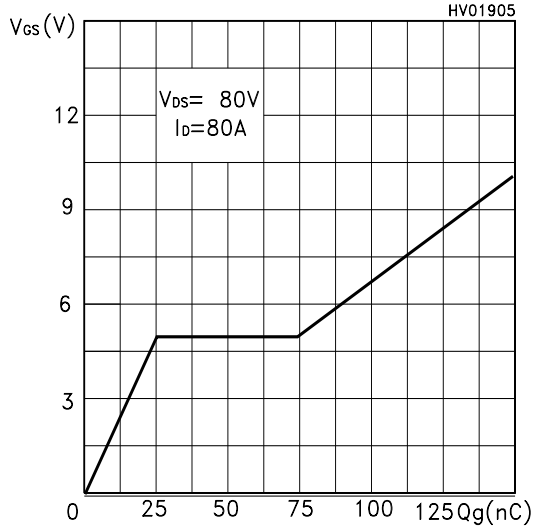

Capacitance Variations

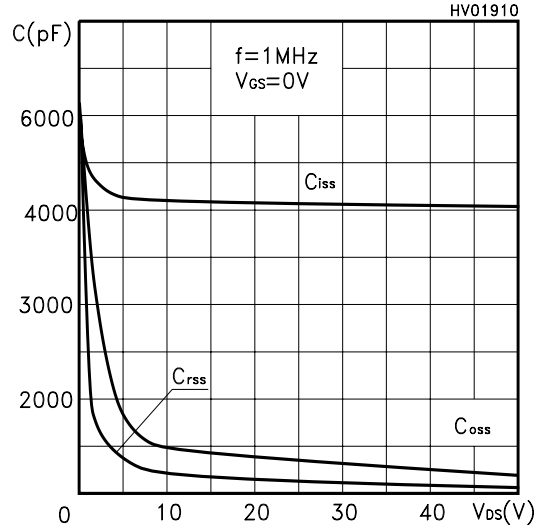

Normalized Gate Threshold Voltage vs Temp.

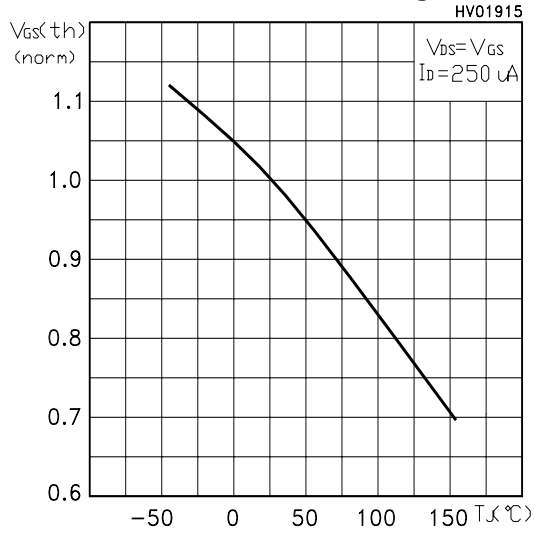

Normalized On Resistance vs Temperature

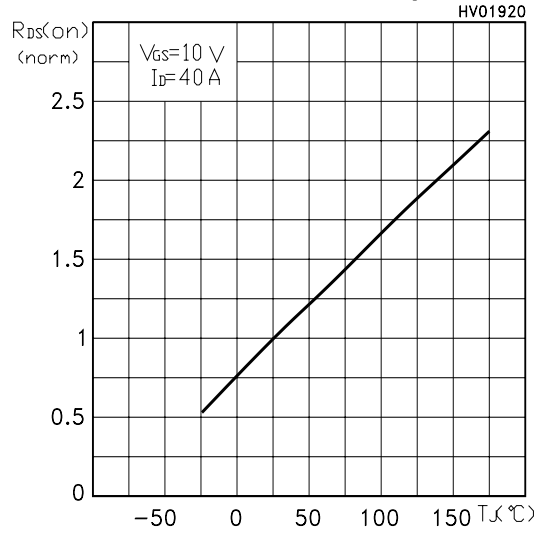

Source-drain Diode Forward Characteristics

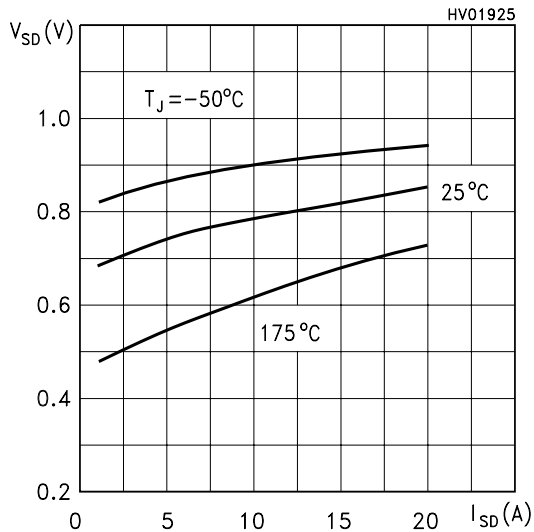

Fig. 1: Unclamped Inductive Load Test Circuit



Fig. 2: Unclamped Inductive Waveform



Fig. 3: Switching Times Test Circuit For Resistive Load



Fig. 4: Gate Charge test Circuit

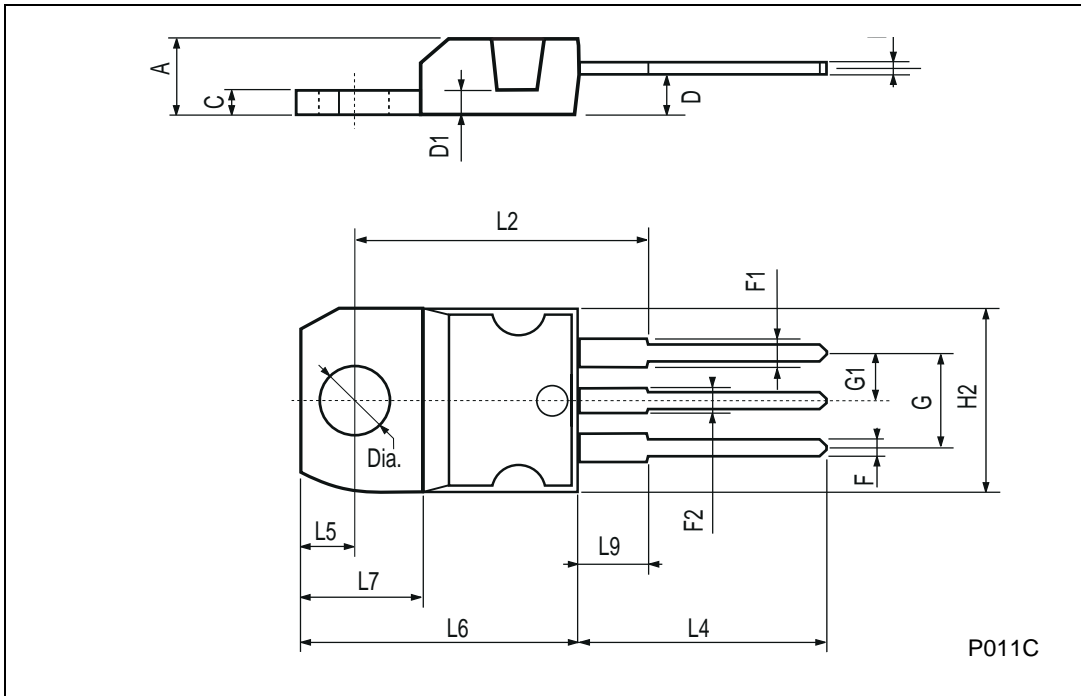

Fig. 5: Test Circuit For Inductive Load Switching And Diode Recovery Times



TO-220 MECHANICAL DATA

DIM.	mm			inch		
	MIN.	TYP.	MAX.	MIN.	TYP.	MAX.
A	4.40		4.60	0.173		0.181
C	1.23		1.32	0.048		0.051
D	2.40		2.72	0.094		0.107
D1		1.27			0.050	
E	0.49		0.70	0.019		0.027
F	0.61		0.88	0.024		0.034
F1	1.14		1.70	0.044		0.067
F2	1.14		1.70	0.044		0.067
G	4.95		5.15	0.194		0.203
G1	2.4		2.7	0.094		0.106
H2	10.0		10.40	0.393		0.409
L2		16.4			0.645	
L4	13.0		14.0	0.511		0.551
L5	2.65		2.95	0.104		0.116
L6	15.25		15.75	0.600		0.620
L7	6.2		6.6	0.244		0.260
L9	3.5		3.93	0.137		0.154
DIA.	3.75		3.85	0.147		0.151



TO-220FP MECHANICAL DATA

DIM.	mm.			inch		
	MIN.	TYP	MAX.	MIN.	TYP.	MAX.
A	4.4		4.6	0.173		0.181
B	2.5		2.7	0.098		0.106
D	2.5		2.75	0.098		0.108
E	0.45		0.7	0.017		0.027
F	0.75		1	0.030		0.039
F1	1.15		1.7	0.045		0.067
F2	1.15		1.7	0.045		0.067
G	4.95		5.2	0.195		0.204
G1	2.4		2.7	0.094		0.106
H	10		10.4	0.393		0.409
L2		16			0.630	
L3	28.6		30.6	1.126		1.204
L4	9.8		10.6	.0385		0.417
L5	2.9		3.6	0.114		0.141
L6	15.9		16.4	0.626		0.645
L7	9		9.3	0.354		0.366
∅	3		3.2	0.118		0.126

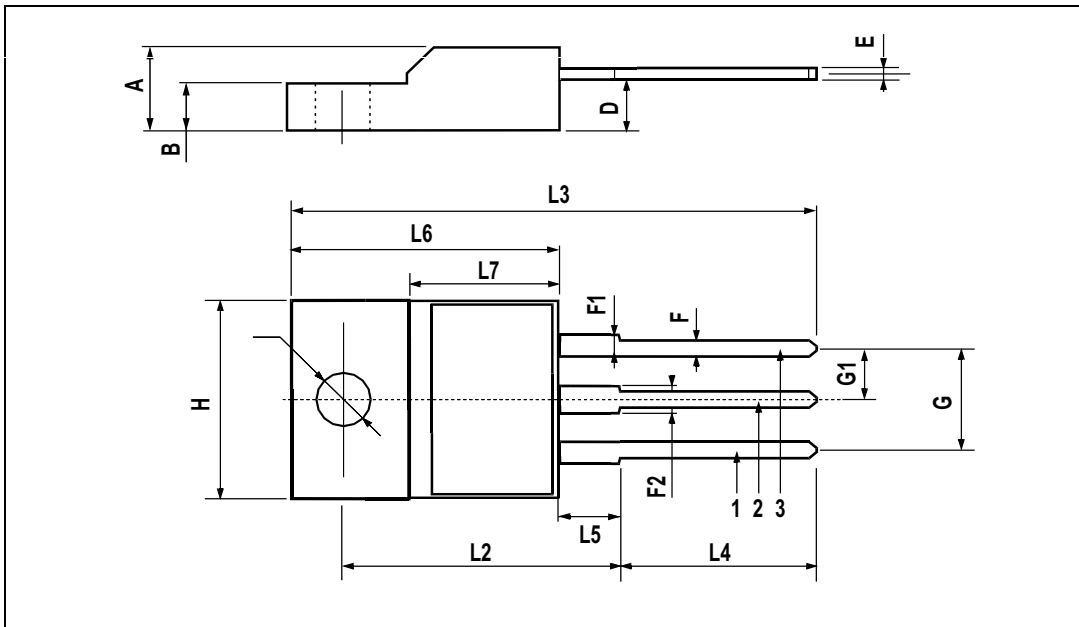

Information furnished is believed to be accurate and reliable. However, STMicroelectronics assumes no responsibility for the consequences of use of such information nor for any infringement of patents or other rights of third parties which may result from its use. No license is granted by implication or otherwise under any patent or patent rights of STMicroelectronics. Specifications mentioned in this publication are subject to change without notice. This publication supersedes and replaces all information previously supplied. STMicroelectronics products are not authorized for use as critical components in life support devices or systems without express written approval of STMicroelectronics.

© The ST logo is a registered trademark of STMicroelectronics

© 2002 STMicroelectronics - Printed in Italy - All Rights Reserved
STMicroelectronics GROUP OF COMPANIES

Australia - Brazil - Canada - China - Finland - France - Germany - Hong Kong - India - Israel - Italy - Japan - Malaysia - Malta - Morocco
Singapore - Spain - Sweden - Switzerland - United Kingdom - United States.

© <http://www.st.com>